

Linear actuator connector clamps base

Item description/product images



Description

Material:

Cast aluminium.

DIN 7984 screws and DIN 985 nuts, steel.

Version:

Black powder-coated.

Screws and nuts electro zinc-plated.

On request:

Clamping levers for tightening.

Drawings

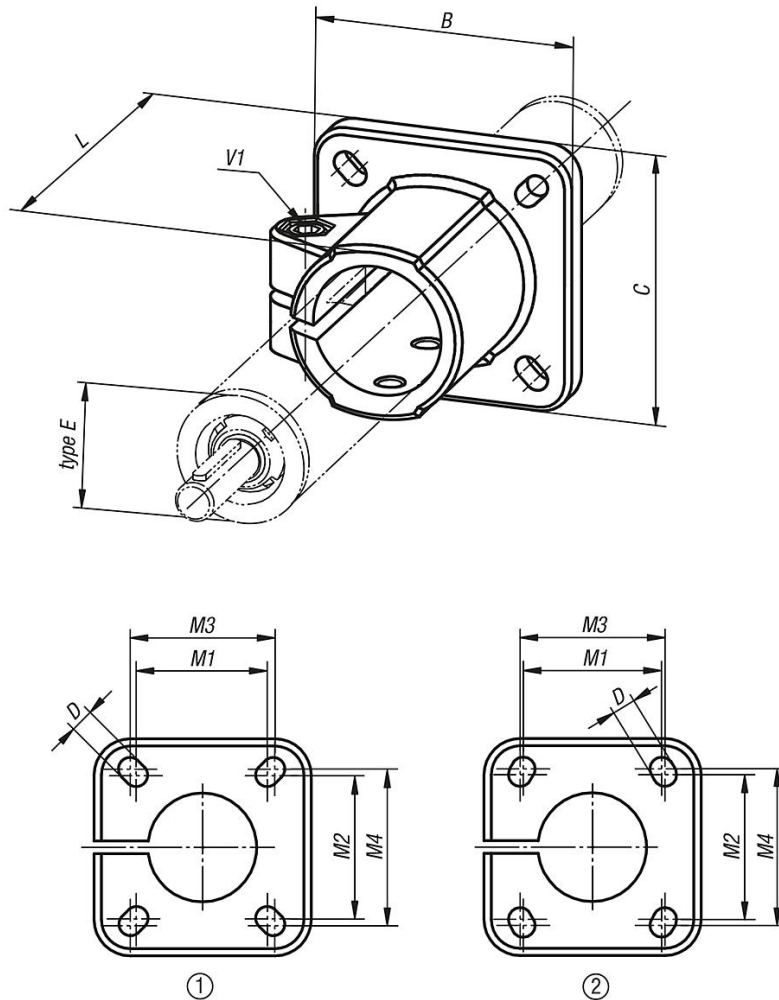

Overview of items

Linear actuator connector clamps base

Linear actuator connector clamps base

Overview of items

Order No.	hole arrangement	Type E	B	C	D	L	M1	M2	M3	M4	V1
K0499.18	1	18	42	42	5,5	37	28	28	30	30	M6x20
K0499.30	2	30	60	60	6,5	50	40	42	42	45	M8x25
K0499.40	1	40	90	90	8,5	70	60	60	64	64	M10x30
K0499.50	1	50	105	105	10,5	85	74	74	80	80	M10x35