





Technical information for safety hinge switches K1499 / K1501



Approvals:	
	UL
	CCC
	EAC
Safety review:	
B ^{10d} Normally closed (NC)	2.000.000
B ^{10d} Normally open (NO)	1.000.000
Service life	20 years
Switching frequency c	120/h
Specifications	EN ISO 13849-1
Note	$MTTF_d = \frac{B_{10d}}{0,1 \times n_{op}} \quad n_{op} = \frac{d_{op} \times h_{op} \times 3600 \text{ s/h}}{t_{cycle}}$
General data:	
Specifications	EN 60947-5-1, BG-GS-ET-15
Conformity to directives (Y/N)	 Yes
Housing material	Die-cast zinc
Contact material	Silver/nickel alloy 10
Housing colour	Silver
Mechanical data:	
Connection type	Connector M12 or cable
Connector	M12, 8-pin, A-coded
Cable	Cable length 3 metres
Connection cross-section	min. 0,5 mm ² / max. 1 mm ²
Mechanical service life:	> 1,000,000 switching cycles
Note	All connection cross-section specifications includes the use of ferrules
Additional hinge (Y/N)	No
Switching angle	3° from set zero point
Assembly stops (Y/N)	Yes
Environmental conditions:	
Ambient temperature	min. -25°C / max. -65°C
Safety rating	IP65 acc. to IEC 60529
Electrical data:	
Switching element version	Normally open (NO), normally closed (NC)
Switching principle	Slow-action contact
No. of auxiliary contacts	1 pc.
Number of safety contacts	2 pc.
Rated operating current / voltage I _o / U _o :	2 A / 230 V AC and 1 A / 24 V DC cable versions 1 A / 24 V DC M12 8-pin connector
Rated impulse voltage strength U _{imp}	2.5 kV cable versions 0.5 kV M12 8-pin connector
Rated insulation voltage U _i	300 V cable versions 30 V M12 8-pin connector (PELV acc. to DIN EN 60204-1)

Technical information for safety hinge switches K1499 / K1501



Rated operating voltage U_e max.	230 V cable versions 30 V M12 8-pin connector
Thermal continuous current I_{the}	2,5 A
Utilisation category	AC-15: 230 V / 2 A DC-13: 24 V / 1 A
Short-circuit protection	2 A gG D fuse
Switching of small loads	1 mA / 3 VDC
ATEX:	
Explosion protection category for gas	None
Explosion protection category for dust	None

Circuit diagram:

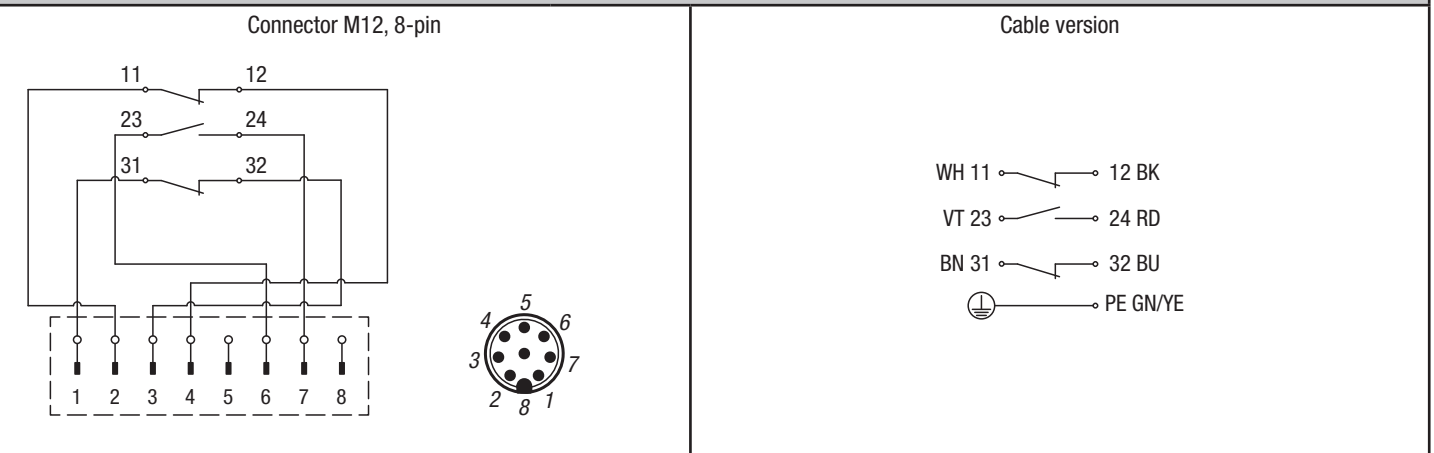

Note on circuit diagram:

- Positively driven NC contact
- actuated
- not actuated
- Normally open contact
- Normally closed contact

Illustration of contacts with closed protective device.

Operating travel diagram:

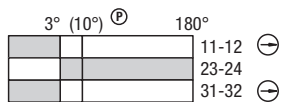

Note on operating travel diagram:

- Closed contact
- Open contact
- Positively driven path/angle
(switching angle tolerance $-1^\circ/+3^\circ$)

The switching paths shown for the NO and NC contacts can be applied to other contact combinations.

Technical information for safety hinge switches K1499 / K1501



Load specifications:

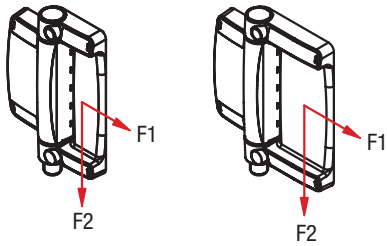

Mechanical breaking load:

- F1: 5000 N
- F2: 5000 N

Permissible forces are determined on the basis of the door size and number of hinges.

Doors with one hinge

Forces (N)		B [mm]				
		100	200	300	400	500
H [mm]	up to 200	200	150	100	70	50
	up to 300	200	150			
not recommended						

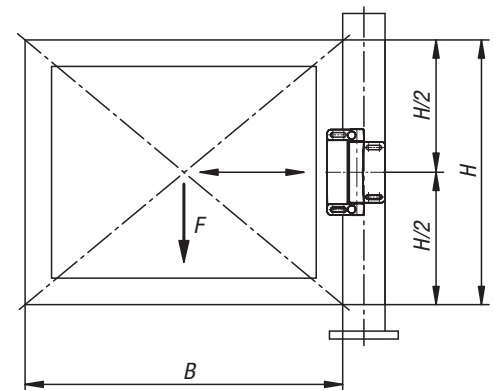

For doors with just one hinge, the hinge must be mounted centrally.

Doors with two hinges

Forces (N)		B [mm]								
		400	500	600	700	800	900	1000	1100	1200
H [mm]	up to 1000	400	400	400	400	400	400	400	400	350
	up to 1800	400	400	400	400	350	350	300	300	250
	up to 2400	400	400	400	300	250	250	200	200	150
	up to 2600	400	400	300	200	150	150	100	100	50
not recommended										

Doors with three hinges

Forces (N)		B [mm]											
		400	500	600	700	800	900	1000	1100	1200	1300	1400	1500
H [mm]	up to 1800	750	750	750	700	650	650	600	600	550	500	450	400
	up to 2400	750	750	700	600	550	550	500	500	450	400	350	300
	up to 2600	750	700	600	500	450	450	400	400	400	400	350	300

Technical information for safety hinge switches K1499 / K1501



- C = Use one hinge switch and one additional hinge
D = Use one hinge switch and two additional hinges

For large doors with 3 hinges, ensure that two hinges are attached to the upper third section of the door.

When using three hinges, we recommend positioning the safety hinge switch in the centre.

The safety hinge switch must not be used as a stop. For applications involving heavy doors, and particularly where there is the possibility of the doors slamming shut with no or only light hindrance, additional measures must be put in place to prevent the fastening screws coming loose and to dampen or brake the doors travel.

By applications involving divergent installations e.g. hoods, a reduced service life is to be expected.

Appropriate dampening or braking measures must be included.

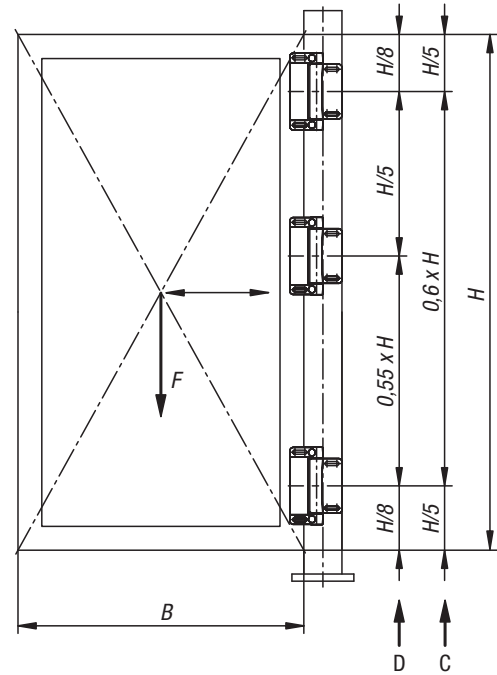

Technical information for safety hinge switches K1499 / K1501



Determining the door gap for a safety hinge switch

Determining the door gap:

This is determined on the basis of the opening angle, door width and overlap.

B	3°	4°	5°	6°	7°	8°	9°	10°
C	D							
100	5,2	7	8,7	10,4	12,2	13,9	15,6	17,4
150	7,8	10,5	13,1	15,7	18,3	20,9	23,5	26
200	10,5	13,9	17,4	20,9	24,4	27,8	31,3	34,7
250	13,1	17,4	21,8	26,1	30,5	34,8	39,1	43,3
300	15,7	20,9	26,1	31,3	36,5	41,7	46,9	52,1
350	18,3	24,4	30,5	36,6	42,6	48,7	54,7	60,7
400	20,9	27,9	34,8	41,8	48,7	55,6	62,5	69,4
450	23,5	31,4	39,2	47	54,8	62,6	70,4	78,1
500	26,2	34,9	43,6	52,2	60,9	69,6	78,2	86,8
550	28,8	38,3	47,9	57,5	67	76,5	86	95,5
600	31,4	41,8	52,3	62,7	73,1	83,5	93,8	104,1
650	34	45,3	56,6	67,9	79,2	90,4	101,6	112,8
700	36,6	48,8	61	73,1	85,3	97,4	109,4	121,5
750	39,2	52,3	65,3	78,4	91,4	104,3	117,3	130,2
800	41,8	55,8	69,7	83,6	97,4	111,3	125,1	138,8
850	44,5	59,3	74	88,8	103,5	118,2	132,9	147,5
900	47,1	62,7	78,4	94	109,6	125,2	140,7	156,2
950	49,7	66,2	82,8	99,3	115,7	132,1	148,5	164,9
1000	52,3	69,7	87,1	104,5	121,8	139,1	156,4	173,6
1050	54,9	73,2	91,5	109,7	127,9	146,1	164,2	182,2
1100	57,5	76,7	95,8	114,9	134	153	172	190,9
1150	60,2	80,2	100,2	120,1	140,1	160	179,8	199,6
1200	62,8	83,7	104,5	125,4	146,2	166,9	187,6	208,3
1250	65,4	87,2	108,9	130,6	152,3	173,9	195,4	217
1300	68	90,6	113,2	135,8	158,4	180,8	203,3	225,6
1350	70,6	94,1	117,6	141	164,4	187,8	211,1	234,3
1400	73,2	97,6	122	146,3	170,5	194,7	218,9	243
1450	75,8	101,1	126,3	151,5	176,6	201,7	226,7	251,7
1500	78,5	104,6	130,7	156,7	182,7	208,7	234,5	260,3

β = Door opening angle
 C = Door width in mm
 D = Door gap in mm with overlap B = 0 mm
 B = Door thickness

The actual door gap D1 is calculated on the basis of the door gap D (taken from the above table) minus the door and frame overlap B:

$$D1 = D - B$$

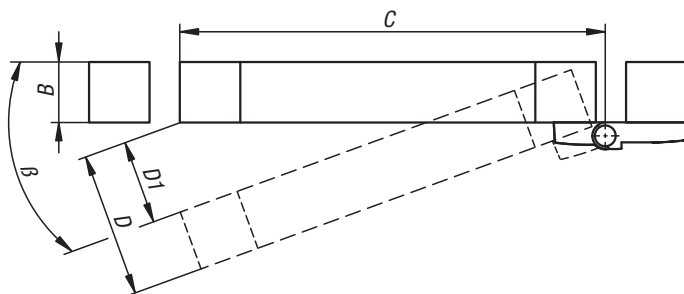

Example:

A 40 mm aluminium profile door with a length of 950 mm is to be secured with a safety hinge switch. According to the technical datasheet, the safety contact of the safety hinge switch opens at 3° when new (10° at the end of its service life).

Based on the table above, this results in a door gap of ca. 49.7 mm when new. The actual door gap, based on the above formula, $D1 = D - B$ is $49.7 - 40 = 9.7$; so $D1 = 9.7$ mm.

At the end of the equipment's service life the door gap will be ca. 164.9 mm with an actual door gap of 124.9 mm ($164.9 - 40$)

Technical information for safety hinge switches K1499 / K1501



Pin assignment of the safety hinge switch and connector:

Connector M12, 8-pin		Pin assignment of the connector	Colour code / wire numbering of the connector acc. to DIN 47100	
				
Connection cables with bush (female) IP6, M12, 8-pin – 8 x 0.25 mm ²		1	WH	1
		2	BN	2
		3	GN	3
		4	YE	4
Cable length	Order No.	5	GY	5
2,5 m	K1498.1208X2500	6	PK	6
5,0 m	K1498.1208X5000	7	BU	7
10,0 m	K1498.1208X10000	8	RD	8

Colour code legend:

Code	Colour	Code	Colour	Code	Colour
WH	white	YE	yellow	BU	blue
BN	brown	GY	grey	RD	red
GN	green	PK	pink		