

## Wing grips "Miniwing" antibacterial internal thread, metal parts stainless steel

Item description/product images



### Description

#### Material:

Thermoplastic, slate grey.

Bush and screw stainless steel 1.4305.

#### Version:

Bush and screw bright.

#### Application:

The antibacterial KIPP MEDI grip products are highly effective against a variety of hazardous microorganisms, such as bacteria, fungi and even multi-resistant bacteria (e.g. MRSA).

The plastic used incorporates micro-silver particles with an antimicrobial effect to ensure effective results throughout the entire product life cycle.

#### Function:

The growth of harmful micro-organisms on the product surface is effectively disrupted by means of silver ions, and the existing germs on MEDI grip products are consistently reduced (as tested and confirmed by an accredited testing laboratory). During cleaning cycles the risk of infection through touching these products is significantly lower.

#### Advantages:

Resistant to humidity and cleaning products (during disinfection) with no toxic side effects.

#### Applications:

For installation on machines, equipment, plants and furnishings in areas with increased hygienic requirements (including hospitals, doctors' surgeries, rehabilitation centres and food production facilities), as well as for use in public areas or regularly frequented institutions (i.e. nursing homes or daycare centres).

### Drawings

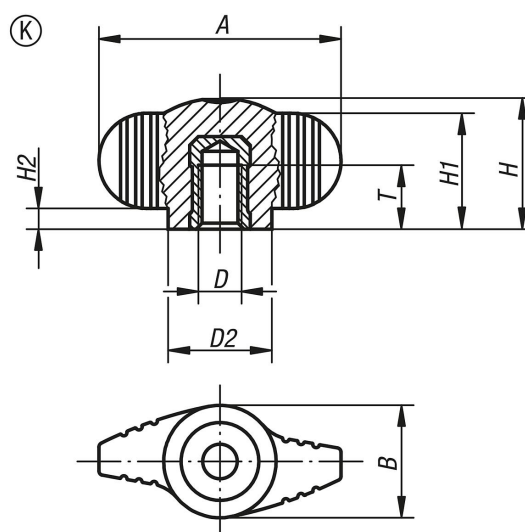

## Wing grips "Miniwing" antibacterial internal thread, metal parts stainless steel

### Overview of items

Order No.	Form	A	B	D	D2	H	H1	H2	T
K0274.120006144	K	28	13	M6	12	15	13,3	2,3	9