

Hinges, stainless steel with fastening screws

Item description/product images



Description

Material:
Stainless steel 1.4301.

Version:
Polished or blasted.

Note:
The high quality stainless steel hinges with fastening screws have an opening angle of 95°. The hinges can be used in the foodstuff, packaging, chemical and pharmaceutical industries.

The hinges are available in polished or abrasive blasted versions.

Drawings

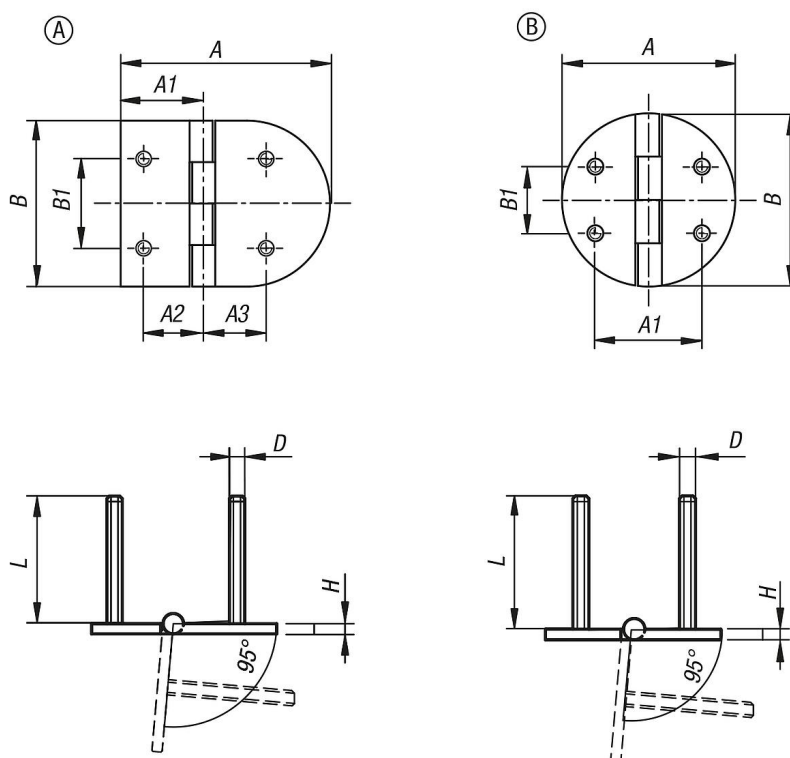

Overview of items

Stainless steel hinges with fastening screws

Order No.	Form	Form definition	Surface finish body	A	A1	A2	A3	B	B1	H	D	L
K1810.82650	A	oval	polished	82	32	23	25	65	32	4	M6	50
K1810.82651	A	oval	blasted	82	32	23	25	65	32	4	M6	50
K1810.65650	B	round	polished	65	40	-	-	65	25	4	M6	50
K1810.65651	B	round	blasted	65	40	-	-	65	25	4	M6	50

