

Hook clamps with collar and cam lever

Item description/product images



Description

Material:

Body and hook, high-carbon steel.
 Handles, cast aluminium EN AC-46200.
 Thrust washer, fibreglass reinforced plastic PA 66 GF 35-X.
 Hinge pin, stud and washer stainless steel 1.4305.

Version:

Body and hook tempered and black oxidised.
 Handles, black powder-coated.
 Thrust washer black.
 Hinge pin, stud and washer bright.

Note:

Ideal for clamping where the parts are to be inserted from above as the hook can be swivelled out of the way.

The exact clamping height is set by the fine thread on the stud using a screwdriver. This setting can be secured with the locking screw. The length S corresponds to the cam travel.

Drawing reference:

- 1) Locking screw for pin
- 2) Screw for fine adjustment of lever

Drawings

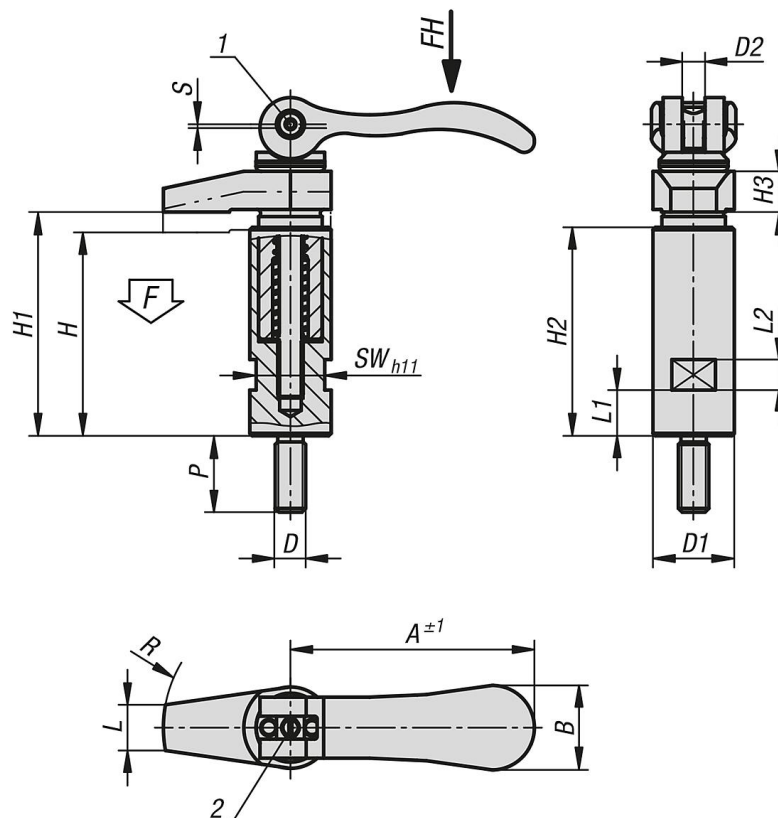

Hook clamps with collar and cam lever

Overview of items

Hook clamps with collar and cam lever

Order No.	D	D1	D2	H	H1	H2	H3	L	L1	L2	A	B	P	R	SW	Travel S	F kN	Hand force FH N
K0013.206	M6	20	M6x0,5	56	60	53	10	9	9	8	70,4	21,5	20	30	17	1,2	4	120
K0013.208	M8	20	M6x0,5	56	60	53	10	9	9	8	70,4	21,5	20	30	17	1,2	4	120
K0013.210	M10	25	M8x0,75	72	79	67	12	12	13	10	96	33,3	25	40	19	1,5	8	350
K0013.212	M12	32	M8x0,75	88	96	82	18	18	18	12	96	33,3	30	50	27	1,5	8	350