

# UNILOCK clamping module ESM 176

## Item description/product images

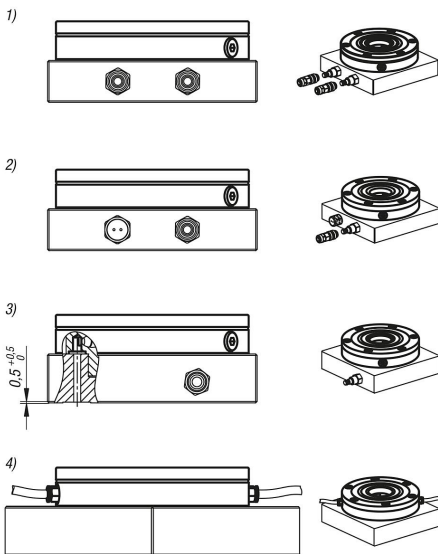

## Description

### Material:

Steel.

### Version:

Contact faces case-hardened and ground.

### Note:

The UNILOCK clamp modules can be mounted in any position, with or without projection on machine tables or as part of fixtures (plates, cubes, towers etc). The pneumatic control of the clamping modules can be carried out independently or together, thus an individual zero-point clamping system can be fabricated. The modular design allows the number of and distance between the clamp modules to be ideally adjusted to suit the clamping task. The set-up times are significantly reduced and so the running times of the machines are extended.

The high clamping forces are generated by the integrated spring package (the unit is clamped without constant air pressure).

The release process is pneumatic.

Even in the event of a pressure drop or fluctuations in the compressed air supply, the full traction force is maintained.

All clamping modules have a turbo function included as standard. A short air impulse at the "Turbo" air port increases the normal traction force, achieved by the springs, significantly. Consequently, the clamping modules can also be used for heavy-feed machining.

Use of the turbo function for maximum traction force is recommended.

The following clamping forces are possible with the UNILOCK clamping pin in conjunction with M10, M12, M16 fastening screws:

- Clamping force (M10) 35,000 N
- Clamping force (M12) 50,000 N
- Clamping force (M16) 75,000 N

Clamping force with DIN EN ISO 4762 -12.9 cap screws

Clamping pins may only be clamped in conjunction with a mounted interchangeable unit in the clamping module.

A consistent clamping bolt size for all clamping modules and compatibility with the 5-axis module clamping system 80 guarantees diverse combinations of application possibilities.

### Technical data:

- Traction force with turbo from 40 kN.
- System pressure: 6 bar, lubricated air.
- Repeat accuracy  $\leq 0.005$  mm.
- Temperature range 5° to 60° C.
- Optional port for blow-out air.
- The third air port can be used as a query function to report if clamping slides are open or closed.

### Advantages:

- Automation-capable through various query options.

## UNILOCK clamping module ESM 176

### Item description/product images

- Turbo-function as standard.
- Repeat accuracy  $\leq 0.005$  mm.
- Positioning via short taper.
- High traction force.
- Setup time optimisation.

#### On request:

Installation clamp with rotation lock.

#### Supplied with:

- 1x clamping module.
- 3x O-rings  $\varnothing 9 \times 1.5$  for media feed.
- 6x fastening screws.
- 6x cover caps for fastening screws.

#### Note:

Recommended nominal hose size:

- Up to four clamping modules, hose size 6 mm.
- From five clamping modules, hose size 8 mm.

#### Functional principle:

The clamping modules can be connected either via the connections on the base plate or directly on the clamping module via the threaded port.

In order to guarantee the function of the clamping slides, the venting of the upper piston chamber must be carried out via the "Turbo" air port.

This can be implemented through one of four options:

- 1) Connection and use of the turbo function in the base plate next to the "Open" port. This also enables the clamping module to be additionally tensioned with a short air pulse if required. (recommended)
- 2) Simple hole in the baseplate connected to the turbo port to permit air to escape. To seal the bore against dirt, use a vent screw instead of a connection with a shut-off function.
- 3) In the third case, the piston chamber must be vented via a bore that is connected below the baseplate via a transverse slot. This bore must join with the turbo port so that venting can take place.
- 4) If the clamping module is controlled from the side, the one vent screw must also be inserted at this point.

#### Drawing reference:

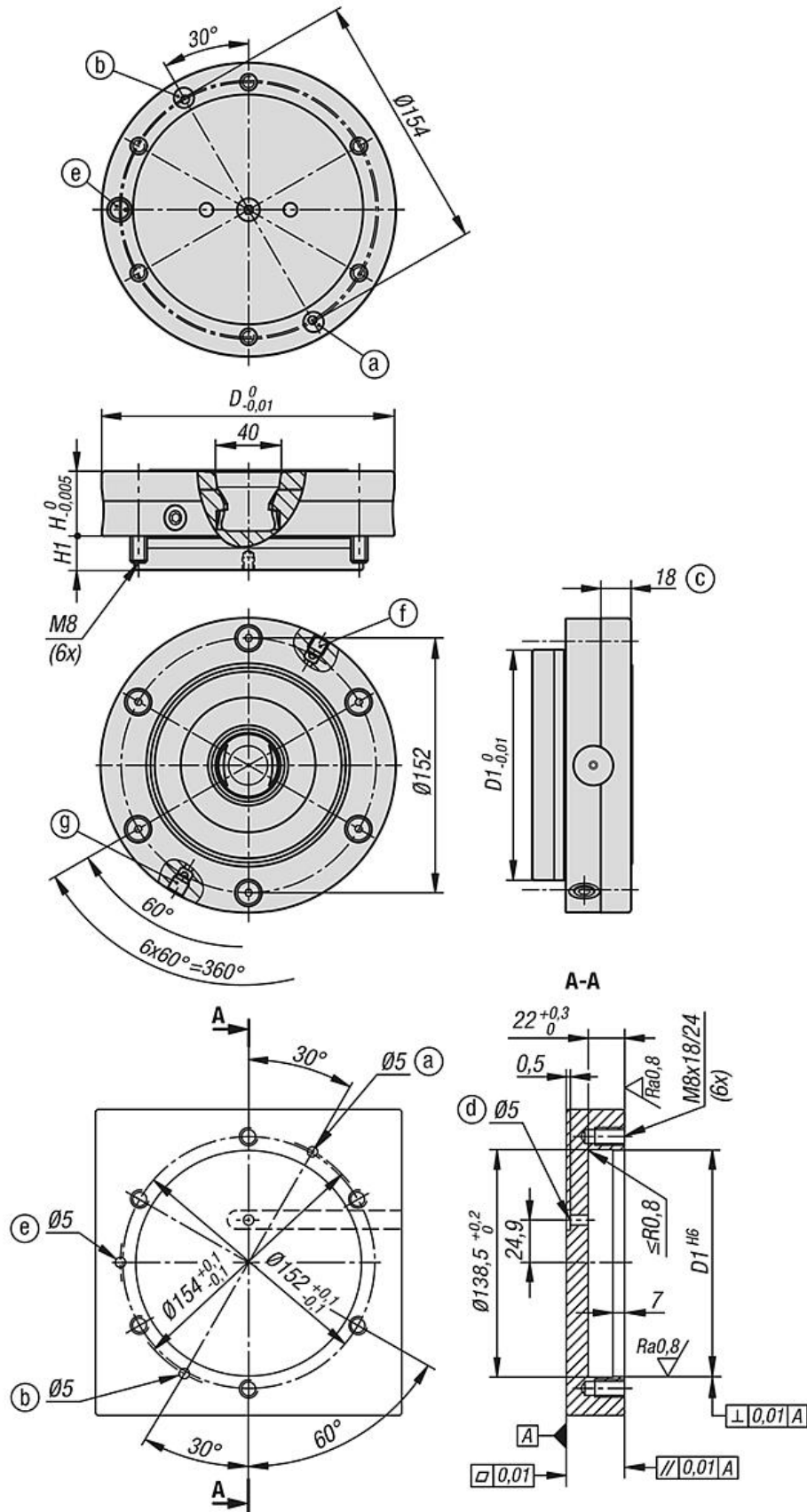

- a) Underside hose-less port (open)  
O-ring  $\varnothing 9 \times 1.5$
- b) Underside hose-less port (turbo)  
O-ring  $\varnothing 9 \times 1.5$
- c) Centring rim
- d) Vent
- e) Underside hose-less port (dynamic pressure detection / clamp slider position)  
O-ring  $\varnothing 9 \times 1.5$
- f) Lateral connection G1/8 (actuator open)
- g) Lateral connection G1/8 (turbo)

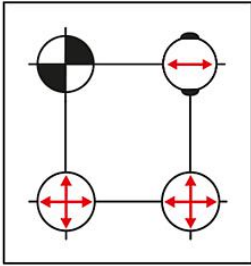

## UNILOCK clamping module ESM 176

### Drawings



-  Centring pins = Form A      fixes in x and y axis (reference point)
-  Adjustment pins = Form B      fixes the free axis (bayonet pin)
-  Tightening bolts = Form C      Pins with undersize  
(no centring function, clamping only)

### Overview of items

#### UNILOCK clamping module ESM 176

Order No.	Form	Form definition	D	D1	H	H1	Operating pressure bar	Retraction force with turbo kN
K1389.176390	A	without rotation lock	176	138	39	20,8	6	40