

Indexing plungers, steel or stainless steel with plastic mushroom grip

Item description/product images

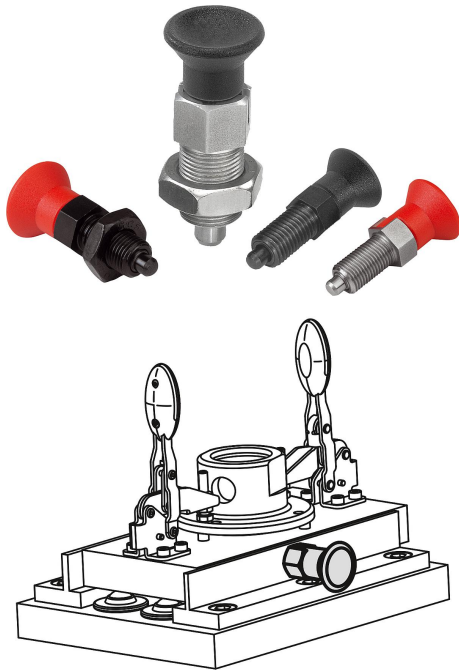

Description

Product description:

Indexing plungers are used where it is necessary to prevent changes of position due to lateral forces.

Some examples of this are for length, height and position indexing in machines, equipment, furniture and special vehicle construction.

A new indexed position can only be moved to after the pin has been manually retracted. Form C and D are recommended for applications where the indexing pin should remain disengaged for an extended period and be prevented from springing back.

The materials used enable diverse applications including those with the highest demands on corrosion resistance

Material:

Steel version:

Threaded sleeve and indexing pin free-cutting steel.

Spring 1.4310.

Stainless steel version A2:

Threaded sleeve 1.4305.

Hardened indexing pin 1.4034.

Not hardened indexing pin 1.4305.

Spring 1.4310.

Stainless steel version A4:

Threaded sleeve and indexing pin 1.4404.

Spring 1.4401 or 1.4571.

Mushroom grip thermoplastic, dark grey or traffic red RAL3020.

Version:

Steel version:

Threaded sleeve, black oxidised.

Indexing pin hardened, ground and black oxidised.

Stainless steel A2 version:

threaded sleeve bright.

Indexing pin hardened or not hardened, ground and bright.

Stainless steel A4 version:

threaded sleeve bright.

Indexing pin ground, chemically nickel-plated or bright.

On request:

Special versions.

Drawing reference:

Form A: non-lockout type, without locknut

Form B: non-lockout type, with locknut

Form C: lockout type, without locknut

Form D: lockout type, with locknut

Indexing plungers, steel or stainless steel with plastic mushroom grip

Drawings

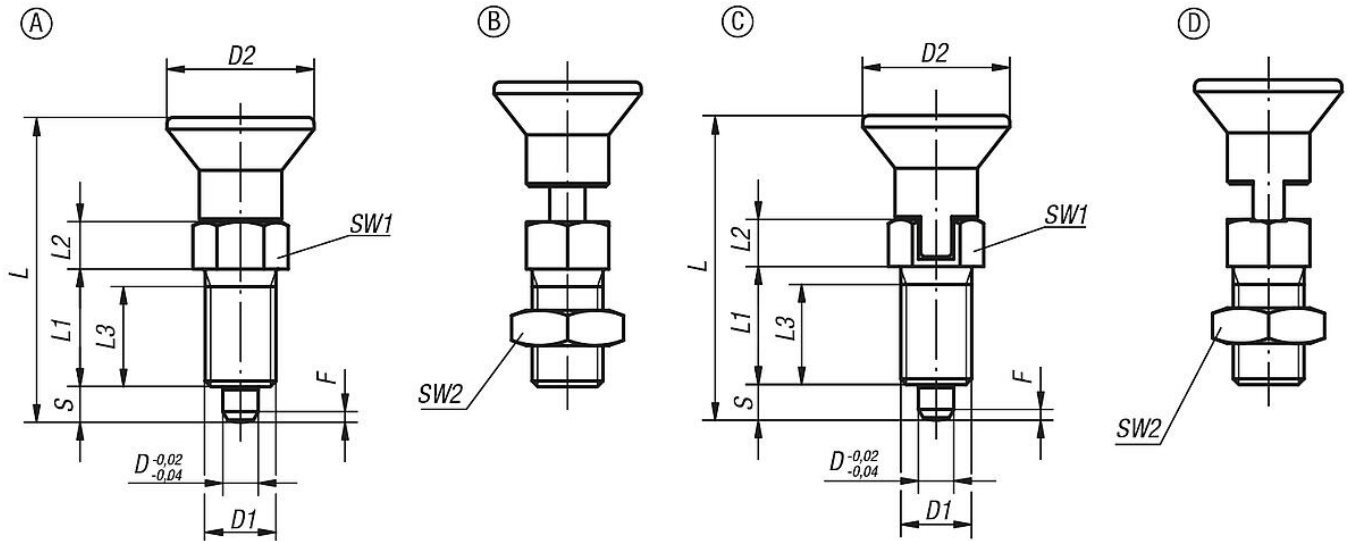

Overview of items

Indexing plungers

Order No.	Form	Main material	Steel code	Surface finish body	Component colour	D	D1	D2	L	L1	L2	L3	Travel S	SW1	SW2	Fx30°	Spring force initial pressure F1 approx. N	Spring force final pressure F2 approx. N
K0338.1903	A	steel	-	hardened	black grey RAL 7021	3	M6x0,75	14	31,5	12	5	10	3,5	8	-	0,8	4,5	10
K0338.1004	A	steel	-	hardened	black grey RAL 7021	4	M8x1	18	38,5	15	6	13	4	10	-	1	6	12
K0338.1105	A	steel	-	hardened	black grey RAL 7021	5	M10x1	21	43,5	17	7	15	5	13	-	1,3	5	12
K0338.1206	A	steel	-	hardened	black grey RAL 7021	6	M12x1,5	25	51,7	20	8	17	6	14	-	1,8	6	14
K0338.1308	A	steel	-	hardened	black grey RAL 7021	8	M16x1,5	33	68	26	10	23	8	19	-	2,3	15	35
K0338.1410	A	steel	-	hardened	black grey RAL 7021	10	M20x1,5	33	74	28	12	25	10	22	-	2,8	15	34
K0338.1412	A	steel	-	hardened	black grey RAL 7021	12	M20x1,5	33	78	28	12	25	12	22	-	2,8	15	39
K0338.1516	A	steel	-	hardened	black grey RAL 7021	16	M24x2	40	96	32	18	28	16	27	-	3,2	20	46
K0338.190384	A	steel	-	hardened	traffic red RAL 3020	3	M6x0,75	14	31,5	12	5	10	3,5	8	-	0,8	4,5	10
K0338.100484	A	steel	-	hardened	traffic red RAL 3020	4	M8x1	18	38,5	15	6	13	4	10	-	1	6	12
K0338.110584	A	steel	-	hardened	traffic red RAL 3020	5	M10x1	21	43,5	17	7	15	5	13	-	1,3	5	12
K0338.120684	A	steel	-	hardened	traffic red RAL 3020	6	M12x1,5	25	51,7	20	8	17	6	14	-	1,8	6	14
K0338.130884	A	steel	-	hardened	traffic red RAL 3020	8	M16x1,5	33	68	26	10	23	8	19	-	2,3	15	35
K0338.141084	A	steel	-	hardened	traffic red RAL 3020	10	M20x1,5	33	74	28	12	25	10	22	-	2,8	15	34
K0338.141284	A	steel	-	hardened	traffic red RAL 3020	12	M20x1,5	33	78	28	12	25	12	22	-	2,8	15	39
K0338.151684	A	steel	-	hardened	traffic red RAL 3020	16	M24x2	40	96	32	18	28	16	27	-	3,2	20	46
K0338.01903	A	stainless steel	1.4034	hardened	black grey RAL 7021	3	M6x0,75	14	31,5	12	5	10	3,5	8	-	0,8	4,5	10
K0338.01004	A	stainless steel	1.4034	hardened	black grey RAL 7021	4	M8x1	18	38,5	15	6	13	4	10	-	1	6	12
K0338.01105	A	stainless steel	1.4034	hardened	black grey RAL 7021	5	M10x1	21	43,5	17	7	15	5	13	-	1,3	5	12
K0338.01206	A	stainless steel	1.4034	hardened	black grey RAL 7021	6	M12x1,5	25	51,7	20	8	17	6	14	-	1,8	6	14
K0338.01308	A	stainless steel	1.4034	hardened	black grey RAL 7021	8	M16x1,5	33	68	26	10	23	8	19	-	2,3	15	35
K0338.01410	A	stainless steel	1.4034	hardened	black grey RAL 7021	10	M20x1,5	33	74	28	12	25	10	22	-	2,8	15	34
K0338.01412	A	stainless steel	1.4034	hardened	black grey RAL 7021	12	M20x1,5	33	78	28	12	25	12	22	-	2,8	15	39
K0338.01516	A	stainless steel	1.4034	hardened	black grey RAL 7021	16	M24x2	40	96	32	18	28	16	27	-	3,2	20	46
K0338.0190384	A	stainless steel	1.4034	hardened	traffic red RAL 3020	3	M6x0,75	14	31,5	12	5	10	3,5	8	-	0,8	4,5	10
K0338.0100484	A	stainless steel	1.4034	hardened	traffic red RAL 3020	4	M8x1	18	38,5	15	6	13	4	10	-	1	6	12
K0338.0110584	A	stainless steel	1.4034	hardened	traffic red RAL 3020	5	M10x1	21	43,5	17	7	15	5	13	-	1,3	5	12
K0338.0120684	A	stainless steel	1.4034	hardened	traffic red RAL 3020	6	M12x1,5	25	51,7	20	8	17	6	14	-	1,8	6	14
K0338.0130884	A	stainless steel	1.4034	hardened	traffic red RAL 3020	8	M16x1,5	33	68	26	10	23	8	19	-	2,3	15	35
K0338.0141084	A	stainless steel	1.4034	hardened	traffic red RAL 3020	10	M20x1,5	33	74	28	12	25	10	22	-	2,8	15	34
K0338.0141284	A	stainless steel	1.4034	hardened	traffic red RAL 3020	12	M20x1,5	33	78	28	12	25	12	22	-	2,8	15	39
K0338.0151684	A	stainless steel	1.4034	hardened	traffic red RAL 3020	16	M24x2	40	96	32	18	28	16	27	-	3,2	20	46
K0338.11903	A	stainless steel	1.4305	not hardened	black grey RAL 7021	3	M6x0,75	14	31,5	12	5	10	3,5	8	-	0,8	4,5	10
K0338.11004	A	stainless steel	1.4305	not hardened	black grey RAL 7021	4	M8x1	18	38,5	15	6	13	4	10	-	1	6	12
K0338.11105	A	stainless steel	1.4305	not hardened	black grey RAL 7021	5	M10x1	21	43,5	17	7	15	5	13	-	1,3	5	12

Indexing plungers, steel or stainless steel with plastic mushroom grip

Overview of items

Order No.	Form	Main material	Steel code	Surface finish body	Component colour	D	D1	D2	L	L1	L2	L3	Travel S	SW1	SW2	Fx30°	Spring force initial pressure F1 approx. N	Spring force final pressure F2 approx. N
K0338.11206	A	stainless steel	1.4305	not hardened	black grey RAL 7021	6	M12x1,5	25	51,7	20	8	17	6	14	-	1,8	6	14
K0338.11308	A	stainless steel	1.4305	not hardened	black grey RAL 7021	8	M16x1,5	33	68	26	10	23	8	19	-	2,3	15	35
K0338.11410	A	stainless steel	1.4305	not hardened	black grey RAL 7021	10	M20x1,5	33	74	28	12	25	10	22	-	2,8	15	34
K0338.11412	A	stainless steel	1.4305	not hardened	black grey RAL 7021	12	M20x1,5	33	78	28	14	25	12	22	-	2,8	15	39
K0338.11516	A	stainless steel	1.4305	not hardened	black grey RAL 7021	16	M24x2	40	96	32	18	28	16	27	-	3,2	20	46
K0338.1190384	A	stainless steel	1.4305	not hardened	traffic red RAL 3020	3	M6x0,75	14	31,5	12	5	10	3,5	8	-	0,8	4,5	10
K0338.1100484	A	stainless steel	1.4305	not hardened	traffic red RAL 3020	4	M8x1	18	38,5	15	6	13	4	10	-	1	6	12
K0338.1110584	A	stainless steel	1.4305	not hardened	traffic red RAL 3020	5	M10x1	21	43,5	17	7	15	5	13	-	1,3	5	12
K0338.1120684	A	stainless steel	1.4305	not hardened	traffic red RAL 3020	6	M12x1,5	25	51,7	20	8	17	6	14	-	1,8	6	14
K0338.1130884	A	stainless steel	1.4305	not hardened	traffic red RAL 3020	8	M16x1,5	33	68	26	10	23	8	19	-	2,3	15	35
K0338.1141084	A	stainless steel	1.4305	not hardened	traffic red RAL 3020	10	M20x1,5	33	74	28	12	25	10	22	-	2,8	15	34
K0338.1141284	A	stainless steel	1.4305	not hardened	traffic red RAL 3020	12	M20x1,5	33	78	28	14	25	12	22	-	2,8	15	39
K0338.1151684	A	stainless steel	1.4305	not hardened	traffic red RAL 3020	16	M24x2	40	96	32	18	28	16	27	-	3,2	20	46
K0338.61903	A	stainless steel	1.4404	nickel-plated	black grey RAL 7021	3	M6x0,75	14	31,5	12	5	10	3,5	8	-	0,8	3	6,5
K0338.61004	A	stainless steel	1.4404	nickel-plated	black grey RAL 7021	4	M8x1	18	38,5	15	6	13	4	10	-	1	7	15,5
K0338.61105	A	stainless steel	1.4404	nickel-plated	black grey RAL 7021	5	M10x1	21	43,5	17	7	15	5	13	-	1,3	4	12,5
K0338.61206	A	stainless steel	1.4404	nickel-plated	black grey RAL 7021	6	M12x1,5	25	51,7	20	8	17	6	14	-	1,8	7	14,5
K0338.61308	A	stainless steel	1.4404	nickel-plated	black grey RAL 7021	8	M16x1,5	33	68	26	10	23	8	19	-	2,3	15	35
K0338.61410	A	stainless steel	1.4404	nickel-plated	black grey RAL 7021	10	M20x1,5	33	74	28	12	25	10	22	-	2,8	15	30
K0338.61412	A	stainless steel	1.4404	nickel-plated	black grey RAL 7021	12	M20x1,5	33	78	28	14	25	12	22	-	2,8	15	39
K0338.61516	A	stainless steel	1.4404	nickel-plated	black grey RAL 7021	16	M24x2	40	96	32	18	28	16	27	-	3,2	20	40
K0338.6190384	A	stainless steel	1.4404	nickel-plated	traffic red RAL 3020	3	M6x0,75	14	31,5	12	5	10	3,5	8	-	0,8	3	6,5
K0338.6100484	A	stainless steel	1.4404	nickel-plated	traffic red RAL 3020	4	M8x1	18	38,5	15	6	13	4	10	-	1	7	15,5
K0338.6110584	A	stainless steel	1.4404	nickel-plated	traffic red RAL 3020	5	M10x1	21	43,5	17	7	15	5	13	-	1,3	4	12,5
K0338.6120684	A	stainless steel	1.4404	nickel-plated	traffic red RAL 3020	6	M12x1,5	25	51,7	20	8	17	6	14	-	1,8	7	14,5
K0338.6130884	A	stainless steel	1.4404	nickel-plated	traffic red RAL 3020	8	M16x1,5	33	68	26	10	23	8	19	-	2,3	15	35
K0338.6141084	A	stainless steel	1.4404	nickel-plated	traffic red RAL 3020	10	M20x1,5	33	74	28	12	25	10	22	-	2,8	15	30
K0338.6141284	A	stainless steel	1.4404	nickel-plated	traffic red RAL 3020	12	M20x1,5	33	78	28	14	25	12	22	-	2,8	15	39
K0338.6151684	A	stainless steel	1.4404	nickel-plated	traffic red RAL 3020	16	M24x2	40	96	32	18	28	16	27	-	3,2	20	40
K0338.71903	A	stainless steel	1.4404	bright	black grey RAL 7021	3	M6x0,75	14	31,5	12	5	10	3,5	8	-	0,8	3	6,5
K0338.71004	A	stainless steel	1.4404	bright	black grey RAL 7021	4	M8x1	18	38,5	15	6	13	4	10	-	1	7	15,5
K0338.71105	A	stainless steel	1.4404	bright	black grey RAL 7021	5	M10x1	21	43,5	17	7	15	5	13	-	1,3	4	12,5
K0338.71206	A	stainless steel	1.4404	bright	black grey RAL 7021	6	M12x1,5	25	51,7	20	8	17	6	14	-	1,8	7	14,5
K0338.71308	A	stainless steel	1.4404	bright	black grey RAL 7021	8	M16x1,5	33	68	26	10	23	8	19	-	2,3	15	35
K0338.71410	A	stainless steel	1.4404	bright	black grey RAL 7021	10	M20x1,5	33	74	28	12	25	10	22	-	2,8	15	30
K0338.71412	A	stainless steel	1.4404	bright	black grey RAL 7021	12	M20x1,5	33	78	28	14	25	12	22	-	2,8	15	39
K0338.71516	A	stainless steel	1.4404	bright	black grey RAL 7021	16	M24x2	40	96	32	18	28	16	27	-	3,2	20	40
K0338.7190384	A	stainless steel	1.4404	bright	traffic red RAL 3020	3	M6x0,75	14	31,5	12	5	10	3,5	8	-	0,8	3	6,5
K0338.7100484	A	stainless steel	1.4404	bright	traffic red RAL 3020	4	M8x1	18	38,5	15	6	13	4	10	-	1	7	15,5
K0338.7110584	A	stainless steel	1.4404	bright	traffic red RAL 3020	5	M10x1	21	43,5	17	7	15	5	13	-	1,3	4	12,5
K0338.7120684	A	stainless steel	1.4404	bright	traffic red RAL 3020	6	M12x1,5	25	51,7	20	8	17	6	14	-	1,8	7	14,5
K0338.7130884	A	stainless steel	1.4404	bright	traffic red RAL 3020	8	M16x1,5	33	68	26	10	23	8	19	-	2,3	15	35
K0338.7141084	A	stainless steel	1.4404	bright	traffic red RAL 3020	10	M20x1,5	33	74	28	12	25	10	22	-	2,8	15	30
K0338.7141284	A	stainless steel	1.4404	bright	traffic red RAL 3020	12	M20x1,5	33	78	28	14	25	12	22	-	2,8	15	39
K0338.7151684	A	stainless steel	1.4404	bright	traffic red RAL 3020	16	M24x2	40	96	32	18	28	16	27	-	3,2	20	40
K0338.2903	B	steel	-	hardened	black grey RAL 7021	3	M6x0,75	14	31,5	12	5	10	3,5	8	10	0,8	4,5	10
K0338.2004	B	steel	-	hardened	black grey RAL 7021	4	M8x1	18	38,5	15	6	13	4	10	13	1	6	12
K0338.2105	B	steel	-	hardened	black grey RAL 7021	5	M10x1	21	43,5	17	7	15	5	13	17	1,3	5	12
K0338.2206	B	steel	-	hardened	black grey RAL 7021	6	M12x1,5	25	51,7	20	8	17	6	14	19	1,8	6	14
K0338.2308	B	steel	-	hardened	black grey RAL 7021	8	M16x1,5	33	68	26	10	23	8	19	24	2,3	15	35
K0338.2410	B	steel	-	hardened	black grey RAL 7021	10	M20x1,5	33	74	28	12	25	10	22	30	2,8	15	34
K0338.2412	B	steel	-	hardened	black grey RAL 7021	12	M20x1,5	33	78	28	14	25	12	22	30	2,8	15	39
K0338.2516	B	steel	-	hardened	black grey RAL 7021	16	M24x2	40	96	32	18	28	16	27	36	3,2	20	46
K0338.290384	B	steel	-	hardened	traffic red RAL 3020	3	M6x0,75	14	31,5	12	5	10	3,5	8	10	0,8	4,5	10
K0338.200484	B	steel	-	hardened	traffic red RAL 3020	4	M8x1	18	38,5	15	6	13	4	10	13	1	6	12
K0338.210584	B	steel	-	hardened	traffic red RAL 3020	5	M10x1	21	43,5	17	7	15	5	13	17	1,3	5	12
K0338.220684	B	steel	-	hardened	traffic red RAL 3020	6	M12x1,5	25	51,7	20	8	17	6	14	19	1,8	6	14
K0338.230884	B	steel	-	hardened	traffic red RAL 3020	8	M16x1,5	33	68	26	10	23	8	19	24	2,3	15	35
K0338.241084	B	steel	-	hardened	traffic red RAL 3020	10	M20x1,5	33	74	28	12	25	10	22	30	2,8	15	34
K0338.241284	B	steel	-	hardened	traffic red RAL 3020	12	M20x1,5	33	78	28	14	25	12	22	30	2,8	15	39
K0338.251684	B	steel	-	hardened	traffic red RAL 3020	16	M24x2	40	96	32	18	28	16	27	36	3,2	20	46

Indexing plungers, steel or stainless steel with plastic mushroom grip

Overview of items

Order No.	Form	Main material	Steel code	Surface finish body	Component colour	D	D1	D2	L	L1	L2	L3	Travel S	SW1	SW2	Fx30°	Spring force initial pressure F1 approx. N	Spring force final pressure F2 approx. N
K0338.02903	B	stainless steel	1.4034	hardened	black grey RAL 7021	3	M6x0,75	14	31,5	12	5	10	3,5	8	10	0,8	4,5	10
K0338.02004	B	stainless steel	1.4034	hardened	black grey RAL 7021	4	M8x1	18	38,5	15	6	13	4	10	13	1	6	12
K0338.02105	B	stainless steel	1.4034	hardened	black grey RAL 7021	5	M10x1	21	43,5	17	7	15	5	13	17	1,3	5	12
K0338.02206	B	stainless steel	1.4034	hardened	black grey RAL 7021	6	M12x1,5	25	51,7	20	8	17	6	14	19	1,8	6	14
K0338.02308	B	stainless steel	1.4034	hardened	black grey RAL 7021	8	M16x1,5	33	68	26	10	23	8	19	24	2,3	15	35
K0338.02410	B	stainless steel	1.4034	hardened	black grey RAL 7021	10	M20x1,5	33	74	28	12	25	10	22	30	2,8	15	34
K0338.02412	B	stainless steel	1.4034	hardened	black grey RAL 7021	12	M20x1,5	33	78	28	14	25	12	22	30	2,8	15	39
K0338.02516	B	stainless steel	1.4034	hardened	black grey RAL 7021	16	M24x2	40	96	32	18	28	16	27	36	3,2	20	46
K0338.0290384	B	stainless steel	1.4034	hardened	traffic red RAL 3020	3	M6x0,75	14	31,5	12	5	10	3,5	8	10	0,8	4,5	10
K0338.0200484	B	stainless steel	1.4034	hardened	traffic red RAL 3020	4	M8x1	18	38,5	15	6	13	4	10	13	1	6	12
K0338.0210584	B	stainless steel	1.4034	hardened	traffic red RAL 3020	5	M10x1	21	43,5	17	7	15	5	13	17	1,3	5	12
K0338.0220684	B	stainless steel	1.4034	hardened	traffic red RAL 3020	6	M12x1,5	25	51,7	20	8	17	6	14	19	1,8	6	14
K0338.0230884	B	stainless steel	1.4034	hardened	traffic red RAL 3020	8	M16x1,5	33	68	26	10	23	8	19	24	2,3	15	35
K0338.0241084	B	stainless steel	1.4034	hardened	traffic red RAL 3020	10	M20x1,5	33	74	28	12	25	10	22	30	2,8	15	34
K0338.0241284	B	stainless steel	1.4034	hardened	traffic red RAL 3020	12	M20x1,5	33	78	28	14	25	12	22	30	2,8	15	39
K0338.0251684	B	stainless steel	1.4034	hardened	traffic red RAL 3020	16	M24x2	40	96	32	18	28	16	27	36	3,2	20	46
K0338.12903	B	stainless steel	1.4305	not hardened	black grey RAL 7021	3	M6x0,75	14	31,5	12	5	10	3,5	8	10	0,8	4,5	10
K0338.12004	B	stainless steel	1.4305	not hardened	black grey RAL 7021	4	M8x1	18	38,5	15	6	13	4	10	13	1	6	12
K0338.12105	B	stainless steel	1.4305	not hardened	black grey RAL 7021	5	M10x1	21	43,5	17	7	15	5	13	17	1,3	5	12
K0338.12206	B	stainless steel	1.4305	not hardened	black grey RAL 7021	6	M12x1,5	25	51,7	20	8	17	6	14	19	1,8	6	14
K0338.12308	B	stainless steel	1.4305	not hardened	black grey RAL 7021	8	M16x1,5	33	68	26	10	23	8	19	24	2,3	15	35
K0338.12410	B	stainless steel	1.4305	not hardened	black grey RAL 7021	10	M20x1,5	33	74	28	12	25	10	22	30	2,8	15	34
K0338.12412	B	stainless steel	1.4305	not hardened	black grey RAL 7021	12	M20x1,5	33	78	28	14	25	12	22	30	2,8	15	39
K0338.12516	B	stainless steel	1.4305	not hardened	black grey RAL 7021	16	M24x2	40	96	32	18	28	16	27	36	3,2	20	46
K0338.1290384	B	stainless steel	1.4305	not hardened	traffic red RAL 3020	3	M6x0,75	14	31,5	12	5	10	3,5	8	10	0,8	4,5	10
K0338.1200484	B	stainless steel	1.4305	not hardened	traffic red RAL 3020	4	M8x1	18	38,5	15	6	13	4	10	13	1	6	12
K0338.1210584	B	stainless steel	1.4305	not hardened	traffic red RAL 3020	5	M10x1	21	43,5	17	7	15	5	13	17	1,3	5	12
K0338.1220684	B	stainless steel	1.4305	not hardened	traffic red RAL 3020	6	M12x1,5	25	51,7	20	8	17	6	14	19	1,8	6	14
K0338.1230884	B	stainless steel	1.4305	not hardened	traffic red RAL 3020	8	M16x1,5	33	68	26	10	23	8	19	24	2,3	15	35
K0338.1241084	B	stainless steel	1.4305	not hardened	traffic red RAL 3020	10	M20x1,5	33	74	28	12	25	10	22	30	2,8	15	34
K0338.1241284	B	stainless steel	1.4305	not hardened	traffic red RAL 3020	12	M20x1,5	33	78	28	14	25	12	22	30	2,8	15	39
K0338.1251684	B	stainless steel	1.4305	not hardened	traffic red RAL 3020	16	M24x2	40	96	32	18	28	16	27	36	3,2	20	46
K0338.62903	B	stainless steel	1.4404	nickel-plated	black grey RAL 7021	3	M6x0,75	14	31,5	12	5	10	3,5	8	10	0,8	3	6,5
K0338.62004	B	stainless steel	1.4404	nickel-plated	black grey RAL 7021	4	M8x1	18	38,5	15	6	13	4	10	13	1	7	15,5
K0338.62105	B	stainless steel	1.4404	nickel-plated	black grey RAL 7021	5	M10x1	21	43,5	17	7	15	5	13	17	1,3	4	12,5
K0338.62206	B	stainless steel	1.4404	nickel-plated	black grey RAL 7021	6	M12x1,5	25	51,7	20	8	17	6	14	19	1,8	7	14,5
K0338.62308	B	stainless steel	1.4404	nickel-plated	black grey RAL 7021	8	M16x1,5	33	68	26	10	23	8	19	24	2,3	15	35
K0338.62410	B	stainless steel	1.4404	nickel-plated	black grey RAL 7021	10	M20x1,5	33	74	28	12	25	10	22	30	2,8	15	30
K0338.62412	B	stainless steel	1.4404	nickel-plated	black grey RAL 7021	12	M20x1,5	33	78	28	14	25	12	22	30	2,8	15	39
K0338.62516	B	stainless steel	1.4404	nickel-plated	black grey RAL 7021	16	M24x2	40	96	32	18	28	16	27	36	3,2	20	40
K0338.6290384	B	stainless steel	1.4404	nickel-plated	traffic red RAL 3020	3	M6x0,75	14	31,5	12	5	10	3,5	8	10	0,8	3	6,5
K0338.6200484	B	stainless steel	1.4404	nickel-plated	traffic red RAL 3020	4	M8x1	18	38,5	15	6	13	4	10	13	1	7	15,5
K0338.6210584	B	stainless steel	1.4404	nickel-plated	traffic red RAL 3020	5	M10x1	21	43,5	17	7	15	5	13	17	1,3	4	12,5
K0338.6220684	B	stainless steel	1.4404	nickel-plated	traffic red RAL 3020	6	M12x1,5	25	51,7	20	8	17	6	14	19	1,8	7	14,5
K0338.6230884	B	stainless steel	1.4404	nickel-plated	traffic red RAL 3020	8	M16x1,5	33	68	26	10	23	8	19	24	2,3	15	35
K0338.6241084	B	stainless steel	1.4404	nickel-plated	traffic red RAL 3020	10	M20x1,5	33	74	28	12	25	10	22	30	2,8	15	30
K0338.6241284	B	stainless steel	1.4404	nickel-plated	traffic red RAL 3020	12	M20x1,5	33	78	28	14	25	12	22	30	2,8	15	39
K0338.6251684	B	stainless steel	1.4404	nickel-plated	traffic red RAL 3020	16	M24x2	40	96	32	18	28	16	27	36	3,2	20	40
K0338.72903	B	stainless steel	1.4404	bright	black grey RAL 7021	3	M6x0,75	14	31,5	12	5	10	3,5	8	10	0,8	3	6,5
K0338.72004	B	stainless steel	1.4404	bright	black grey RAL 7021	4	M8x1	18	38,5	15	6	13	4	10	13	1	7	15,5
K0338.72105	B	stainless steel	1.4404	bright	black grey RAL 7021	5	M10x1	21	43,5	17	7	15	5	13	17	1,3	4	12,5
K0338.72206	B	stainless steel	1.4404	bright	black grey RAL 7021	6	M12x1,5	25	51,7	20	8	17	6	14	19	1,8	7	14,5
K0338.72308	B	stainless steel	1.4404	bright	black grey RAL 7021	8	M16x1,5	33	68	26	10	23	8	19	24	2,3	15	35
K0338.72410	B	stainless steel	1.4404	bright	black grey RAL 7021	10	M20x1,5	33	74	28	12	25	10	22	30	2,8	15	30
K0338.72412	B	stainless steel	1.4404	bright	black grey RAL 7021	12	M20x1,5	33	78	28	14	25	12	22	30	2,8	15	39
K0338.72516	B	stainless steel	1.4404	bright	black grey RAL 7021	16	M24x2	40	96	32	18	28	16	27	36	3,2	20	40
K0338.7290384	B	stainless steel	1.4404	bright	traffic red RAL 3020	3	M6x0,75	14	31,5	12	5	10	3,5	8	10	0,8	3	6,5
K0338.7200484	B	stainless steel	1.4404	bright	traffic red RAL 3020	4	M8x1	18	38,5	15	6	13	4	10	13	1	7	15,5
K0338.7210584	B	stainless steel	1.4404	bright	traffic red RAL 3020	5	M10x1	21	43,5	17	7	15	5	13	17	1,3	4	12,5
K0338.7220684	B	stainless steel	1.4404	bright	traffic red RAL 3020	6	M12x1,5	25	51,7	20	8	17	6	14	19	1,8	7	14,5
K0338.7230884	B	stainless steel	1.4404	bright	traffic red RAL 3020	8	M16x1,5	33	68	26	10	23	8	19	24	2,3	15	35

Indexing plungers, steel or stainless steel with plastic mushroom grip

Overview of items

Order No.	Form	Main material	Steel code	Surface finish body	Component colour	D	D1	D2	L	L1	L2	L3	Travel S	SW1	SW2	Fx30°	Spring force initial pressure F1 approx. N	Spring force final pressure F2 approx. N	
K0338.7241084	B	stainless steel	1.4404	bright	traffic red RAL 3020	10	M20x1,5	33	74	28	12	25	10	10	22	30	2,8	15	30
K0338.7241284	B	stainless steel	1.4404	bright	traffic red RAL 3020	12	M20x1,5	33	78	28	14	25	10	12	22	30	2,8	15	39
K0338.7251684	B	stainless steel	1.4404	bright	traffic red RAL 3020	16	M24x2	40	96	32	18	28	10	16	27	36	3,2	20	40
K0338.3903	C	steel	-	hardened	black grey RAL 7021	3	M6x0,75	14	31,5	12	5	10	3,5	8	-	0,8	4,5	10	
K0338.3004	C	steel	-	hardened	black grey RAL 7021	4	M8x1	18	38,5	15	6	13	4	10	-	1	6	12	
K0338.3105	C	steel	-	hardened	black grey RAL 7021	5	M10x1	21	43,5	17	7	15	5	13	-	1,3	5	12	
K0338.3206	C	steel	-	hardened	black grey RAL 7021	6	M12x1,5	25	51,7	20	8	17	6	14	-	1,8	6	14	
K0338.3308	C	steel	-	hardened	black grey RAL 7021	8	M16x1,5	33	68	26	10	23	8	19	-	2,3	15	35	
K0338.3410	C	steel	-	hardened	black grey RAL 7021	10	M20x1,5	33	74	28	12	25	10	10	22	-	2,8	15	34
K0338.3412	C	steel	-	hardened	black grey RAL 7021	12	M20x1,5	33	78	28	14	25	10	12	22	-	2,8	15	39
K0338.3516	C	steel	-	hardened	black grey RAL 7021	16	M24x2	40	96	32	18	28	10	16	27	-	3,2	20	46
K0338.390384	C	steel	-	hardened	traffic red RAL 3020	3	M6x0,75	14	31,5	12	5	10	3,5	8	-	0,8	4,5	10	
K0338.300484	C	steel	-	hardened	traffic red RAL 3020	4	M8x1	18	38,5	15	6	13	4	10	-	1	6	12	
K0338.310584	C	steel	-	hardened	traffic red RAL 3020	5	M10x1	21	43,5	17	7	15	5	13	-	1,3	5	12	
K0338.320684	C	steel	-	hardened	traffic red RAL 3020	6	M12x1,5	25	51,7	20	8	17	6	14	-	1,8	6	14	
K0338.330884	C	steel	-	hardened	traffic red RAL 3020	8	M16x1,5	33	68	26	10	23	8	19	-	2,3	15	35	
K0338.341084	C	steel	-	hardened	traffic red RAL 3020	10	M20x1,5	33	74	28	12	25	10	10	22	-	2,8	15	34
K0338.341284	C	steel	-	hardened	traffic red RAL 3020	12	M20x1,5	33	78	28	14	25	10	12	22	-	2,8	15	39
K0338.351684	C	steel	-	hardened	traffic red RAL 3020	16	M24x2	40	96	32	18	28	10	16	27	-	3,2	20	46
K0338.03903	C	stainless steel	1.4034	hardened	black grey RAL 7021	3	M6x0,75	14	31,5	12	5	10	3,5	8	-	0,8	4,5	10	
K0338.03004	C	stainless steel	1.4034	hardened	black grey RAL 7021	4	M8x1	18	38,5	15	6	13	4	10	-	1	6	12	
K0338.03105	C	stainless steel	1.4034	hardened	black grey RAL 7021	5	M10x1	21	43,5	17	7	15	5	13	-	1,3	5	12	
K0338.03206	C	stainless steel	1.4034	hardened	black grey RAL 7021	6	M12x1,5	25	51,7	20	8	17	6	14	-	1,8	6	14	
K0338.03308	C	stainless steel	1.4034	hardened	black grey RAL 7021	8	M16x1,5	33	68	26	10	23	8	19	-	2,3	15	35	
K0338.03410	C	stainless steel	1.4034	hardened	black grey RAL 7021	10	M20x1,5	33	74	28	12	25	10	10	22	-	2,8	15	34
K0338.03412	C	stainless steel	1.4034	hardened	black grey RAL 7021	12	M20x1,5	33	78	28	14	25	10	12	22	-	2,8	15	39
K0338.03516	C	stainless steel	1.4034	hardened	black grey RAL 7021	16	M24x2	40	96	32	18	28	10	16	27	-	3,2	20	46
K0338.0390384	C	stainless steel	1.4034	hardened	traffic red RAL 3020	3	M6x0,75	14	31,5	12	5	10	3,5	8	-	0,8	4,5	10	
K0338.0300484	C	stainless steel	1.4034	hardened	traffic red RAL 3020	4	M8x1	18	38,5	15	6	13	4	10	-	1	6	12	
K0338.0310584	C	stainless steel	1.4034	hardened	traffic red RAL 3020	5	M10x1	21	43,5	17	7	15	5	13	-	1,3	5	12	
K0338.0320684	C	stainless steel	1.4034	hardened	traffic red RAL 3020	6	M12x1,5	25	51,7	20	8	17	6	14	-	1,8	6	14	
K0338.0330884	C	stainless steel	1.4034	hardened	traffic red RAL 3020	8	M16x1,5	33	68	26	10	23	8	19	-	2,3	15	35	
K0338.0341084	C	stainless steel	1.4034	hardened	traffic red RAL 3020	10	M20x1,5	33	74	28	12	25	10	10	22	-	2,8	15	34
K0338.0341284	C	stainless steel	1.4034	hardened	traffic red RAL 3020	12	M20x1,5	33	78	28	14	25	10	12	22	-	2,8	15	39
K0338.0351684	C	stainless steel	1.4034	hardened	traffic red RAL 3020	16	M24x2	40	96	32	18	28	10	16	27	-	3,2	20	46
K0338.13903	C	stainless steel	1.4305	not hardened	black grey RAL 7021	3	M6x0,75	14	31,5	12	5	10	3,5	8	-	0,8	4,5	10	
K0338.13004	C	stainless steel	1.4305	not hardened	black grey RAL 7021	4	M8x1	18	38,5	15	6	13	4	10	-	1	6	12	
K0338.13105	C	stainless steel	1.4305	not hardened	black grey RAL 7021	5	M10x1	21	43,5	17	7	15	5	13	-	1,3	5	12	
K0338.13206	C	stainless steel	1.4305	not hardened	black grey RAL 7021	6	M12x1,5	25	51,7	20	8	17	6	14	-	1,8	6	14	
K0338.13308	C	stainless steel	1.4305	not hardened	black grey RAL 7021	8	M16x1,5	33	68	26	10	23	8	19	-	2,3	15	35	
K0338.13410	C	stainless steel	1.4305	not hardened	black grey RAL 7021	10	M20x1,5	33	74	28	12	25	10	10	22	-	2,8	15	34
K0338.13412	C	stainless steel	1.4305	not hardened	black grey RAL 7021	12	M20x1,5	33	78	28	14	25	10	12	22	-	2,8	15	39
K0338.13516	C	stainless steel	1.4305	not hardened	black grey RAL 7021	16	M24x2	40	96	32	18	28	10	16	27	-	3,2	20	46
K0338.1390384	C	stainless steel	1.4305	not hardened	traffic red RAL 3020	3	M6x0,75	14	31,5	12	5	10	3,5	8	-	0,8	4,5	10	
K0338.1300484	C	stainless steel	1.4305	not hardened	traffic red RAL 3020	4	M8x1	18	38,5	15	6	13	4	10	-	1	6	12	
K0338.1310584	C	stainless steel	1.4305	not hardened	traffic red RAL 3020	5	M10x1	21	43,5	17	7	15	5	13	-	1,3	5	12	
K0338.1320684	C	stainless steel	1.4305	not hardened	traffic red RAL 3020	6	M12x1,5	25	51,7	20	8	17	6	14	-	1,8	6	14	
K0338.1330884	C	stainless steel	1.4305	not hardened	traffic red RAL 3020	8	M16x1,5	33	68	26	10	23	8	19	-	2,3	15	35	
K0338.1341084	C	stainless steel	1.4305	not hardened	traffic red RAL 3020	10	M20x1,5	33	74	28	12	25	10	10	22	-	2,8	15	34
K0338.1341284	C	stainless steel	1.4305	not hardened	traffic red RAL 3020	12	M20x1,5	33	78	28	14	25	10	12	22	-	2,8	15	39
K0338.1351684	C	stainless steel	1.4305	not hardened	traffic red RAL 3020	16	M24x2	40	96	32	18	28	10	16	27	-	3,2	20	46
K0338.63903	C	stainless steel	1.4404	nickel-plated	black grey RAL 7021	3	M6x0,75	14	31,5	12	5	10	3,5	8	-	0,8	3	6,5	
K0338.63004	C	stainless steel	1.4404	nickel-plated	black grey RAL 7021	4	M8x1	18	38,5	15	6	13	4	10	-	1	7	15,5	
K0338.63105	C	stainless steel	1.4404	nickel-plated	black grey RAL 7021	5	M10x1	21	43,5	17	7	15	5	13	-	1,3	4	12,5	
K0338.63206	C	stainless steel	1.4404	nickel-plated	black grey RAL 7021	6	M12x1,5	25	51,7	20	8	17	6	14	-	1,8	7	14,5	
K0338.63308	C	stainless steel	1.4404	nickel-plated	black grey RAL 7021	8	M16x1,5	33	68	26	10	23	8	19	-	2,3	15	35	
K0338.63410	C	stainless steel	1.4404	nickel-plated	black grey RAL 7021	10	M20x1,5	33	74	28	12	25	10	10	22	-	2,8	15	30
K0338.63412	C	stainless steel	1.4404	nickel-plated	black grey RAL 7021	12	M20x1,5	33	78	28	14	25	10	12	22	-	2,8	15	39
K0338.63516	C	stainless steel	1.4404	nickel-plated	black grey RAL 7021	16	M24x2	40	96	32	18	28	10	16	27	-	3,2	20	40
K0338.6390384	C	stainless steel	1.4404	nickel-plated	traffic red RAL 3020	3	M6x0,75	14	31,5	12	5	10	3,5	8	-	0,8	3	6,5	
K0338.6300484	C	stainless steel	1.4404	nickel-plated	traffic red RAL 3020	4	M8x1	18	38,5	15	6	13	4	10	-	1	7	15,5	

Indexing plungers, steel or stainless steel with plastic mushroom grip

Overview of items

Order No.	Form	Main material	Steel code	Surface finish body	Component colour	D	D1	D2	L	L1	L2	L3	Travel S	SW1	SW2	Fx30°	Spring force initial pressure F1 approx. N	Spring force final pressure F2 approx. N
K0338.6310584	C	stainless steel	1.4404	nickel-plated	traffic red RAL 3020	5	M10x1	21	43,5	17	7	15	5	13	-	1,3	4	12,5
K0338.6320684	C	stainless steel	1.4404	nickel-plated	traffic red RAL 3020	6	M12x1,5	25	51,7	20	8	17	6	14	-	1,8	7	14,5
K0338.6330884	C	stainless steel	1.4404	nickel-plated	traffic red RAL 3020	8	M16x1,5	33	68	26	10	23	8	19	-	2,3	15	35
K0338.6341084	C	stainless steel	1.4404	nickel-plated	traffic red RAL 3020	10	M20x1,5	33	74	28	12	25	10	22	-	2,8	15	30
K0338.6341284	C	stainless steel	1.4404	nickel-plated	traffic red RAL 3020	12	M20x1,5	33	78	28	14	25	12	22	-	2,8	15	39
K0338.6351684	C	stainless steel	1.4404	nickel-plated	traffic red RAL 3020	16	M24x2	40	96	32	18	28	16	27	-	3,2	20	40
K0338.73903	C	stainless steel	1.4404	bright	black grey RAL 7021	3	M6x0,75	14	31,5	12	5	10	3,5	8	-	0,8	3	6,5
K0338.73004	C	stainless steel	1.4404	bright	black grey RAL 7021	4	M8x1	18	38,5	15	6	13	4	10	-	1	7	15,5
K0338.73105	C	stainless steel	1.4404	bright	black grey RAL 7021	5	M10x1	21	43,5	17	7	15	5	13	-	1,3	4	12,5
K0338.73206	C	stainless steel	1.4404	bright	black grey RAL 7021	6	M12x1,5	25	51,7	20	8	17	6	14	-	1,8	7	14,5
K0338.73308	C	stainless steel	1.4404	bright	black grey RAL 7021	8	M16x1,5	33	68	26	10	23	8	19	-	2,3	15	35
K0338.73410	C	stainless steel	1.4404	bright	black grey RAL 7021	10	M20x1,5	33	74	28	12	25	10	22	-	2,8	15	30
K0338.73412	C	stainless steel	1.4404	bright	black grey RAL 7021	12	M20x1,5	33	78	28	14	25	12	22	-	2,8	15	39
K0338.73516	C	stainless steel	1.4404	bright	black grey RAL 7021	16	M24x2	40	96	32	18	28	16	27	-	3,2	20	40
K0338.7390384	C	stainless steel	1.4404	bright	traffic red RAL 3020	3	M6x0,75	14	31,5	12	5	10	3,5	8	-	0,8	3	6,5
K0338.7300484	C	stainless steel	1.4404	bright	traffic red RAL 3020	4	M8x1	18	38,5	15	6	13	4	10	-	1	7	15,5
K0338.7310584	C	stainless steel	1.4404	bright	traffic red RAL 3020	5	M10x1	21	43,5	17	7	15	5	13	-	1,3	4	12,5
K0338.7320684	C	stainless steel	1.4404	bright	traffic red RAL 3020	6	M12x1,5	25	51,7	20	8	17	6	14	-	1,8	7	14,5
K0338.7330884	C	stainless steel	1.4404	bright	traffic red RAL 3020	8	M16x1,5	33	68	26	10	23	8	19	-	2,3	15	35
K0338.7341084	C	stainless steel	1.4404	bright	traffic red RAL 3020	10	M20x1,5	33	74	28	12	25	10	22	-	2,8	15	30
K0338.7341284	C	stainless steel	1.4404	bright	traffic red RAL 3020	12	M20x1,5	33	78	28	14	25	12	22	-	2,8	15	39
K0338.7351684	C	stainless steel	1.4404	bright	traffic red RAL 3020	16	M24x2	40	96	32	18	28	16	27	-	3,2	20	40
K0338.4903	D	steel	-	hardened	black grey RAL 7021	3	M6x0,75	14	31,5	12	5	10	3,5	8	10	0,8	4,5	10
K0338.4004	D	steel	-	hardened	black grey RAL 7021	4	M8x1	18	38,5	15	6	13	4	10	13	1	6	12
K0338.4105	D	steel	-	hardened	black grey RAL 7021	5	M10x1	21	43,5	17	7	15	5	13	17	1,3	5	12
K0338.4206	D	steel	-	hardened	black grey RAL 7021	6	M12x1,5	25	51,7	20	8	17	6	14	19	1,8	6	14
K0338.4308	D	steel	-	hardened	black grey RAL 7021	8	M16x1,5	33	68	26	10	23	8	19	24	2,3	15	35
K0338.4410	D	steel	-	hardened	black grey RAL 7021	10	M20x1,5	33	74	28	12	25	10	22	30	2,8	15	34
K0338.4412	D	steel	-	hardened	black grey RAL 7021	12	M20x1,5	33	78	28	14	25	12	22	30	2,8	15	39
K0338.4516	D	steel	-	hardened	black grey RAL 7021	16	M24x2	40	96	32	18	28	16	27	36	3,2	20	46
K0338.490384	D	stainless steel	1.4034	hardened	black grey RAL 7021	3	M6x0,75	14	31,5	12	5	10	3,5	8	10	0,8	4,5	10
K0338.04004	D	stainless steel	1.4034	hardened	black grey RAL 7021	4	M8x1	18	38,5	15	6	13	4	10	13	1	6	12
K0338.04105	D	stainless steel	1.4034	hardened	black grey RAL 7021	5	M10x1	21	43,5	17	7	15	5	13	17	1,3	5	12
K0338.04206	D	stainless steel	1.4034	hardened	black grey RAL 7021	6	M12x1,5	25	51,7	20	8	17	6	14	19	1,8	6	14
K0338.04308	D	stainless steel	1.4034	hardened	black grey RAL 7021	8	M16x1,5	33	68	26	10	23	8	19	24	2,3	15	35
K0338.04410	D	stainless steel	1.4034	hardened	black grey RAL 7021	10	M20x1,5	33	74	28	12	25	10	22	30	2,8	15	34
K0338.04412	D	stainless steel	1.4034	hardened	black grey RAL 7021	12	M20x1,5	33	78	28	14	25	12	22	30	2,8	15	39
K0338.04516	D	stainless steel	1.4034	hardened	black grey RAL 7021	16	M24x2	40	96	32	18	28	16	27	36	3,2	20	46
K0338.0490384	D	stainless steel	1.4034	hardened	traffic red RAL 3020	3	M6x0,75	14	31,5	12	5	10	3,5	8	10	0,8	4,5	10
K0338.0400484	D	stainless steel	1.4034	hardened	traffic red RAL 3020	4	M8x1	18	38,5	15	6	13	4	10	13	1	6	12
K0338.0410584	D	stainless steel	1.4034	hardened	traffic red RAL 3020	5	M10x1	21	43,5	17	7	15	5	13	17	1,3	5	12
K0338.0420684	D	stainless steel	1.4034	hardened	traffic red RAL 3020	6	M12x1,5	25	51,7	20	8	17	6	14	19	1,8	6	14
K0338.0430884	D	stainless steel	1.4034	hardened	traffic red RAL 3020	8	M16x1,5	33	68	26	10	23	8	19	24	2,3	15	35
K0338.0441084	D	stainless steel	1.4034	hardened	traffic red RAL 3020	10	M20x1,5	33	74	28	12	25	10	22	30	2,8	15	34
K0338.0441284	D	stainless steel	1.4034	hardened	traffic red RAL 3020	12	M20x1,5	33	78	28	14	25	12	22	30	2,8	15	39
K0338.0451684	D	stainless steel	1.4034	hardened	traffic red RAL 3020	16	M24x2	40	96	32	18	28	16	27	36	3,2	20	46
K0338.14903	D	stainless steel	1.4305	not hardened	black grey RAL 7021	3	M6x0,75	14	31,5	12	5	10	3,5	8	10	0,8	4,5	10
K0338.14004	D	stainless steel	1.4305	not hardened	black grey RAL 7021	4	M8x1	18	38,5	15	6	13	4	10	13	1	6	12
K0338.14105	D	stainless steel	1.4305	not hardened	black grey RAL 7021	5	M10x1	21	43,5	17	7	15	5	13	17	1,3	5	12
K0338.14206	D	stainless steel	1.4305	not hardened	black grey RAL 7021	6	M12x1,5	25	51,7	20	8	17	6	14	19	1,8	6	14
K0338.14308	D	stainless steel	1.4305	not hardened	black grey RAL 7021	8	M16x1,5	33	68	26	10	23	8	19	24	2,3	15	35
K0338.14410	D	stainless steel	1.4305	not hardened	black grey RAL 7021	10	M20x1,5	33	74	28	12	25	10	22	30	2,8	15	34
K0338.14412	D	stainless steel	1.4305	not hardened	black grey RAL 7021	12	M20x1,5	33	78	28	14	25	12	22	30	2,8	15	39

Indexing plungers, steel or stainless steel with plastic mushroom grip

Overview of items

Order No.	Form	Main material	Steel code	Surface finish body	Component colour	D	D1	D2	L	L1	L2	L3	Travel S	SW1	SW2	Fx30°	Spring force initial pressure F1 approx. N	Spring force final pressure F2 approx. N
K0338.14516	D	stainless steel	1.4305	not hardened	black grey RAL 7021	16	M24x2	40	96	32	18	28	16	27	36	3,2	20	46
K0338.1490384	D	stainless steel	1.4305	not hardened	traffic red RAL 3020	3	M6x0,75	14	31,5	12	5	10	3,5	8	10	0,8	4,5	10
K0338.1400484	D	stainless steel	1.4305	not hardened	traffic red RAL 3020	4	M8x1	18	38,5	15	6	13	4	10	13	1	6	12
K0338.1410584	D	stainless steel	1.4305	not hardened	traffic red RAL 3020	5	M10x1	21	43,5	17	7	15	5	13	17	1,3	5	12
K0338.1420684	D	stainless steel	1.4305	not hardened	traffic red RAL 3020	6	M12x1,5	25	51,7	20	8	17	6	14	19	1,8	6	14
K0338.1430884	D	stainless steel	1.4305	not hardened	traffic red RAL 3020	8	M16x1,5	33	68	26	10	23	8	19	24	2,3	15	35
K0338.1441084	D	stainless steel	1.4305	not hardened	traffic red RAL 3020	10	M20x1,5	33	74	28	12	25	10	22	30	2,8	15	34
K0338.1441284	D	stainless steel	1.4305	not hardened	traffic red RAL 3020	12	M20x1,5	33	78	28	14	25	12	22	30	2,8	15	39
K0338.1451684	D	stainless steel	1.4305	not hardened	traffic red RAL 3020	16	M24x2	40	96	32	18	28	16	27	36	3,2	20	46
K0338.64903	D	stainless steel	1.4404	nickel-plated	black grey RAL 7021	3	M6x0,75	14	31,5	12	5	10	3,5	8	10	0,8	3	6,5
K0338.64004	D	stainless steel	1.4404	nickel-plated	black grey RAL 7021	4	M8x1	18	38,5	15	6	13	4	10	13	1	7	15,5
K0338.64105	D	stainless steel	1.4404	nickel-plated	black grey RAL 7021	5	M10x1	21	43,5	17	7	15	5	13	17	1,3	4	12,5
K0338.64206	D	stainless steel	1.4404	nickel-plated	black grey RAL 7021	6	M12x1,5	25	51,7	20	8	17	6	14	19	1,8	7	14,5
K0338.64308	D	stainless steel	1.4404	nickel-plated	black grey RAL 7021	8	M16x1,5	33	68	26	10	23	8	19	24	2,3	15	35
K0338.64410	D	stainless steel	1.4404	nickel-plated	black grey RAL 7021	10	M20x1,5	33	74	28	12	25	10	22	30	2,8	15	30
K0338.64412	D	stainless steel	1.4404	nickel-plated	black grey RAL 7021	12	M20x1,5	33	78	28	14	25	12	22	30	2,8	15	39
K0338.64516	D	stainless steel	1.4404	nickel-plated	black grey RAL 7021	16	M24x2	40	96	32	18	28	16	27	36	3,2	20	40
K0338.6490384	D	stainless steel	1.4404	nickel-plated	traffic red RAL 3020	3	M6x0,75	14	31,5	12	5	10	3,5	8	10	0,8	3	6,5
K0338.6400484	D	stainless steel	1.4404	nickel-plated	traffic red RAL 3020	4	M8x1	18	38,5	15	6	13	4	10	13	1	7	15,5
K0338.6410584	D	stainless steel	1.4404	nickel-plated	traffic red RAL 3020	5	M10x1	21	43,5	17	7	15	5	13	17	1,3	4	12,5
K0338.6420684	D	stainless steel	1.4404	nickel-plated	traffic red RAL 3020	6	M12x1,5	25	51,7	20	8	17	6	14	19	1,8	7	14,5
K0338.6430884	D	stainless steel	1.4404	nickel-plated	traffic red RAL 3020	8	M16x1,5	33	68	26	10	23	8	19	24	2,3	15	35
K0338.6441084	D	stainless steel	1.4404	nickel-plated	traffic red RAL 3020	10	M20x1,5	33	74	28	12	25	10	22	30	2,8	15	30
K0338.6441284	D	stainless steel	1.4404	nickel-plated	traffic red RAL 3020	12	M20x1,5	33	78	28	14	25	12	22	30	2,8	15	39
K0338.6451684	D	stainless steel	1.4404	nickel-plated	traffic red RAL 3020	16	M24x2	40	96	32	18	28	16	27	36	3,2	20	40
K0338.74903	D	stainless steel	1.4404	bright	black grey RAL 7021	3	M6x0,75	14	31,5	12	5	10	3,5	8	10	0,8	3	6,5
K0338.74004	D	stainless steel	1.4404	bright	black grey RAL 7021	4	M8x1	18	38,5	15	6	13	4	10	13	1	7	15,5
K0338.74105	D	stainless steel	1.4404	bright	black grey RAL 7021	5	M10x1	21	43,5	17	7	15	5	13	17	1,3	4	12,5
K0338.74206	D	stainless steel	1.4404	bright	black grey RAL 7021	6	M12x1,5	25	51,7	20	8	17	6	14	19	1,8	7	14,5
K0338.74308	D	stainless steel	1.4404	bright	black grey RAL 7021	8	M16x1,5	33	68	26	10	23	8	19	24	2,3	15	35
K0338.74410	D	stainless steel	1.4404	bright	black grey RAL 7021	10	M20x1,5	33	74	28	12	25	10	22	30	2,8	15	30
K0338.74412	D	stainless steel	1.4404	bright	black grey RAL 7021	12	M20x1,5	33	78	28	14	25	12	22	30	2,8	15	39
K0338.74516	D	stainless steel	1.4404	bright	black grey RAL 7021	16	M24x2	40	96	32	18	28	16	27	36	3,2	20	40
K0338.7490384	D	stainless steel	1.4404	bright	traffic red RAL 3020	3	M6x0,75	14	31,5	12	5	10	3,5	8	10	0,8	3	6,5
K0338.7400484	D	stainless steel	1.4404	bright	traffic red RAL 3020	4	M8x1	18	38,5	15	6	13	4	10	13	1	7	15,5
K0338.7410584	D	stainless steel	1.4404	bright	traffic red RAL 3020	5	M10x1	21	43,5	17	7	15	5	13	17	1,3	4	12,5
K0338.7420684	D	stainless steel	1.4404	bright	traffic red RAL 3020	6	M12x1,5	25	51,7	20	8	17	6	14	19	1,8	7	14,5
K0338.7430884	D	stainless steel	1.4404	bright	traffic red RAL 3020	8	M16x1,5	33	68	26	10	23	8	19	24	2,3	15	35
K0338.7441084	D	stainless steel	1.4404	bright	traffic red RAL 3020	10	M20x1,5	33	74	28	12	25	10	22	30	2,8	15	30
K0338.7441284	D	stainless steel	1.4404	bright	traffic red RAL 3020	12	M20x1,5	33	78	28	14	25	12	22	30	2,8	15	39
K0338.7451684	D	stainless steel	1.4404	bright	traffic red RAL 3020	16	M24x2	40	96	32	18	28	16	27	36	3,2	20	40