

# Spring plungers with head

## Item description/product images



### Description

**Material:**  
Steel or stainless steel.

**Version:**  
Steel black oxidised.  
Stainless steel bright.  
Ball steel or stainless steel, hardened, bright.

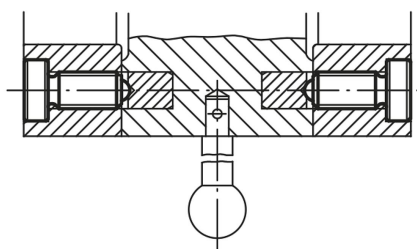

## Drawings

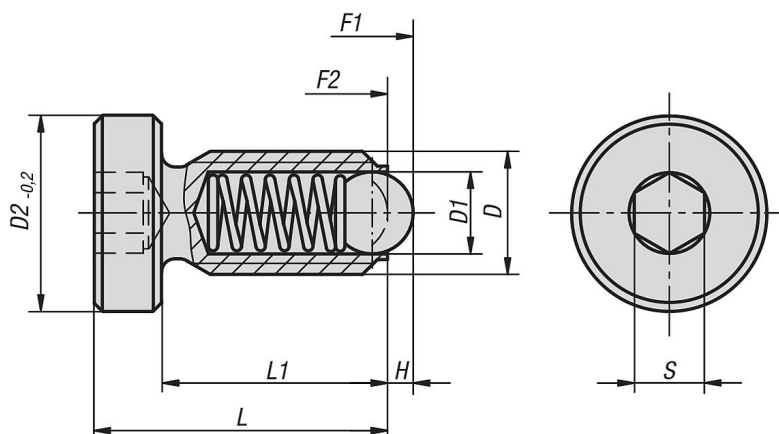

## Overview of items

### Spring plungers with head

Order No.	Main material	D	D1	D2	H	L	L1	S	Spring force initial pressure F1 approx. N	Spring force final pressure F2 approx. N
K0336.04	steel	M4	2,5	7	0,8	13	10	2	4	10
K0336.05	steel	M5	3	8,5	0,9	17	13	2,5	6	11
K0336.06	steel	M6	3,5	10	1	16	12	3	9	13
K0336.08	steel	M8	5	13	1,5	21	16	4	15	30
K0336.10	steel	M10	6	16	2	26	20	5	20	40
K0336.12	steel	M12	8	18	2,5	32	25	6	30	55
K0336.041	stainless steel	M4	2,5	7	0,8	13	10	2	4	10
K0336.051	stainless steel	M5	3	8,5	0,9	17	13	2,5	6	11
K0336.061	stainless steel	M6	3,5	10	1	16	12	3	9	13
K0336.081	stainless steel	M8	5	13	1,5	21	16	4	15	30
K0336.101	stainless steel	M10	6	16	2	26	20	5	20	35
K0336.121	stainless steel	M12	8	18	2,5	32	25	6	30	55

